

# ETIAM MARS

DICOM Conformance Statement

Product Version: 4.28  
Revision: 13  
Date: November 2017

## **ETIAM SOLUTIONS**

La Palmeraie, ZA de la Hallerais – 11 rue du bois de  
Soeuvres  
35770 Vern-sur-Seiche – France  
Phone : +33 (0)2 99 14 33 88

[info@etiam.com](mailto:info@etiam.com)

[www.etiam.com](http://www.etiam.com)



## 1 Conformance Statement Overview

MARS is a DICOM image storage database with associated DICOM services.

MARS is an ETIAM SOLUTIONS automatic CD/DVD generation solutions for medical imaging.

MARS implements the necessary services to

- Verify communication with other DICOM applications, by issuing both verification request and response
- Receive images through its DICOM Store SCP service
- Supports DICOM Query And Retrieve as SCP
- Query images to a remote system and retrieve them to one of its Local AE Titles
- Writes the received images on CD-R, DVD-R and DVD+R conform to the Application Media Profiles related to CD/DVD in DICOM Standard (PS 3.10).

This document is intended to describe MARS conformance to DICOM.

Table 1-1 presents an overview of all network services and the applicable SOP classes as provided by MARS.

**Table 1-1: Network Services**

SOP Classes	User of Service (SCU)	Provider of Service (SCP)
<b>Communication</b>		
Verification (ECHO)	Yes	Yes
<b>Transfer</b>		
Computed Radiography Image Storage	Yes	Yes
Digital XRay Image Storage For Presentation	Yes	Yes
Digital XRay Image Storage For Processing	Yes	Yes
Digital Mammography Xray Image Storage For Presentation	Yes	Yes
Digital Mammography Xray Image Storage For Processing	Yes	Yes
Digital Intra Oral XRay Image Storage For Presentation	Yes	Yes
Digital Intra Oral XRay Image Storage For Processing	Yes	Yes



Revision: 12  
Date: June 2016

SOP Classes	User of Service (SCU)	Provider of Service (SCP)
CT Image Storage	Yes	Yes
Enhanced CT Image Storage	Yes	Yes
US Multiframe Image Storage (RET)	Yes	Yes
US Multiframe Image Storage	Yes	Yes
MR Image Storage	Yes	Yes
Enhanced MR Image Storage	Yes	Yes
MR Spectroscopy Storage	Yes	Yes
NM Image Storage (RET)	Yes	Yes
US Image Storage (RET)	Yes	Yes
US Image Storage	Yes	Yes
Secondary Capture Image Storage	Yes	Yes
Multiframe Secondary Capture Single Bit Image Storage	Yes	Yes
Multiframe Secondary Capture Byte Image Storage	Yes	Yes
Multiframe Secondary Capture Word Image Storage	Yes	Yes
Multiframe Secondary Capture True Color Image Storage	Yes	Yes
Twelve Lead ECG Waveform Storage	Yes	Yes
General ECG Waveform Storage	Yes	Yes
Ambulatory ECG Waveform Storage	Yes	Yes
Hemodynamic Waveform Storage	Yes	Yes
Cardiac Electrophysiologic Audio Waveform Storage	Yes	Yes
Basic Voice Audio Waveform Storage	Yes	Yes
Grayscale Softcopy Presentation State Storage	Yes	Yes
XRy Angiographic Image Storage	Yes	Yes
XRy Fluoroscopy Image Storage	Yes	Yes
XRy Angiographic BiPlane Image Storage (RET)	Yes	Yes
Xray 3D Angiographic Image Storage	Yes	Yes



Revision: 12  
Date: June 2016

SOP Classes	User of Service (SCU)	Provider of Service (SCP)
Xray 3D Craniofacial Image Storage	Yes	Yes
NM Image Storage	Yes	Yes
RT Image Storage	Yes	Yes
RT Dose Storage	Yes	Yes
RT Structure Set Storage	Yes	Yes
RT Beams Treatment Record Storage	Yes	Yes
RT Plan Storage	Yes	Yes
RT Brachy Treatment Record Storage	Yes	Yes
RT Treatment Summary Record Storage	Yes	Yes
PET Image Storage	Yes	Yes
PET Curve Storage	Yes	Yes
Stored Print Storage	Yes	Yes
Hardcopy Grayscale Image Storage	Yes	Yes
Hardcopy Color Image Storage	Yes	Yes
Raw Data Storage	Yes	Yes
Spatial Registration Storage	Yes	Yes
Spatial Fiducial Storage	Yes	Yes
VL Endoscopic Image Storage	Yes	Yes
Video Endoscopic Image Storage	Yes	Yes
VL Microscopic Image Storage	Yes	Yes
Video Microscopic Image Storage	Yes	Yes
VL Slide Coordinates Microscopic Image Storage	Yes	Yes
VL Photographic Image Storage	Yes	Yes
Video Photographic Image Storage	Yes	Yes
Ophthalmic Photography 8Bit Image Storage	Yes	Yes
Ophthalmic Photography 16Bit Image Storage	Yes	Yes
Stereometric Relationship Storage	Yes	Yes
Ophthalmic Tomography Image Storage	Yes	Yes
Basic Text SR	Yes	Yes



SOP Classes	User of Service (SCU)	Provider of Service (SCP)
Enhanced SR	Yes	Yes
Comprehensive SR	Yes	Yes
Procedure Log Storage	Yes	Yes
Mammography CADSR	Yes	Yes
Key Object Selection Document	Yes	Yes
Chest CADSR	Yes	Yes
Encapsulated PDF Storage	Yes	Yes
Encapsulated CDA Storage	Yes	Yes
Private Fuji CR Image Storage	Yes	Yes
PrivateToshiba Raw Data Storage	Yes	Yes
<b>Query/Retrieve</b>		
Study Root Query/Retrieve Information Model – FIND	Yes	Yes
Study Root Query/Retrieve Information Model – MOVE	Yes	Yes

**Table 1-2 Media Services**

Media Storage Application Profile	Write Files (FSC / FSU)	Read Files (FSR)
<b>Compact Disk – Recordable</b>		
STD-GEN-CD	Yes / No	No
STD-CTMR-CD	Yes / No	No
STD-XABC-CD	Yes / No	No
STD-DEN-CD	Yes / No	No
STD-US-CD	Yes / No	No
FULL-GEN-CD-DVD (Private)	Yes / No	No
<b>DVD</b>		
STD-GEN-DVD	Yes/No	No
STD-DVD-MPEG2-MPML	Yes/No	No
FULL-GEN-CD-DVD (Private)	Yes / No	No

## Table of Contents

■ 1. Conformance Statement Overview .....	2
■ Table of Contents.....	6
■ 2. Introduction .....	8
2.1 Revision History.....	8
2.2 Audience.....	8
2.3 Remarks .....	8
2.4 Definitions, Terms and Abbreviations .....	10
■ 3. Networking .....	11
3.1 Implementation Model .....	11
3.1.1 Application Data flow .....	11
3.1.2 Functional Definitions of the Application Entity .....	13
3.1.2.1 Verification Service as SCU.....	13
3.1.2.2 Verification Service as SCP .....	13
3.1.2.3 Image Storage Service as SCU .....	13
3.1.2.4 Image Storage Service as SCP.....	13
3.1.2.5 Query and Retrieve Service as SCU.....	13
3.1.2.6 Query and Retrieve Service as SCP .....	13
3.1.2.7 Color / Grayscale Printing Service as SCU.....	14
3.1.2.8 File Set Creator (FSC) .....	14
3.1.3 Sequencing of Real-Word Activities.....	14
3.2 Application Entity Specifications.....	15
3.2.1 SOP Classes .....	15
3.2.2 Association Policies .....	19
3.2.2.1 General.....	19
3.2.2.2 Number of Associations.....	19
3.2.2.3 Asynchronous Nature.....	19
3.2.2.4 Implementation Identifying Information.....	19
3.2.2.5 Association Initiation Policy .....	20
3.2.2.6 Association Acceptance Policy.....	35
3.3 Network Interface .....	44
3.3.1 Physical Network Interface.....	44
3.3.2 Additional Protocols .....	44
3.4 Configuration .....	44
3.4.1 AE Titles / Presentation Address Mapping .....	44
3.4.1.1 Local AETitles.....	44
3.4.1.2 Remote AETitle / Presentation Address Mapping.....	45
3.4.2 Parameters .....	45
■ 4. Media Interchange.....	45
4.1 Implementation Model .....	45



4.1.1	Application Data flow .....	45
4.1.2	Functional Definitions of Application Entities.....	46
4.1.2.1	Functional Definition of Media Creation Application Entity.....	46
4.1.3	Sequencing of Real-Word Activities.....	46
4.1.4	File Meta Information for Implementation Class and Version .....	46
4.2	Application Entity Specifications.....	46
4.2.1	CD/DVD Creation Application Entity Specification.....	46
4.2.1.1	File Meta Information for the Media Creation Application Entity .....	47
4.2.1.2	Real-World Activities.....	47
4.3	Augmented and Private Application Profiles.....	47
4.3.1	Augmented Application Profiles .....	47
4.3.1.1	FULL-GEN-CD-DVD .....	48
4.4	Media Configuration.....	48
■ 5.	Support of Extended Character Sets .....	49
■ 6.	Security .....	51
■ 7.	Annexes.....	51
7.1	IOD Contents .....	51
7.1.1	Created SOP Instances .....	51
7.1.2	Usage of Attributes from Received IOD's.....	57
7.1.3	Attribute mapping.....	58
7.1.4	Coerced/Modified fields.....	58
7.2	Data Dictionary of Private Attributes .....	58
7.3	Coded Terminology and Templates.....	58
7.4	Grayscale Image Consistency .....	58
7.5	Standard Extended/Specialized/Private SOP Classes .....	58
7.6	Private Transfer Syntaxes .....	58



## 2 Introduction

### 2.1 Revision History

Document Version	Date	Author	Description
1	10/04/03	Mevel, Boissé, Guignot	Document creation
2	25/04/04	Boissé	Update v1.20
3	27/09/05	Guignot	Update v1.30
4	17/11/05	Marchionini	Update document presentation for compliance with DICOM 2004 standard
5	27/12/05	Marchionini	Update v2.00
6	09/06/06	Marchionini	Update v3.00
7	23/04/07	Mevel	Update v3.00 R3
8	08/02/09	Boissé	Update v4.02b
9	05/03/12	Boissé	Update v4.10
10	30/05/13	Boissé	Update v4.20
11	28/02/14	Boissé	Update v4.22

### 2.2 Audience

This document is intended for:

- Potential users
- System integrators of medical equipment
- Software designers implementing DICOM interfaces

It is assumed that the reader has a working understanding of DICOM.

Experience and familiarity with DICOM Conformance Statements is helpful but not required.

### 2.3 Remarks

DICOM, by itself, does not guarantee interoperability. However, the Conformance Statement facilitates a first-level validation for interoperability between different applications supporting the same DICOM functionality.



Revision: 12  
Date: June 2016

This Conformance Statement is not intended to replace validation with other DICOM equipment to ensure proper exchange of information intended.

The scope of this Conformance Statement is to facilitate communication between MARS and other DICOM systems. The Conformance Statement should be read and understood in conjunction with the DICOM Standard (DICOM). However, by itself it is not guaranteed to ensure the desired interoperability and a successful interconnectivity.

The user should be aware of the following important issues:

- The comparison of different Conformance Statements is the first step towards assessing interconnectivity between MARS and other DICOM conformant equipment.
- Test procedures should be defined to validate the desired level of connectivity.
- The DICOM standard will evolve to meet the users' future requirements. ETIAM SOLUTIONS is actively involved in developing the standard further and therefore reserves the right to make changes to its products or to discontinue its delivery.

## 2.4 Definitions, Terms and Abbreviations

Definitions, terms and abbreviations used in this document are defined within the different parts of the DICOM standard.

Abbreviations and terms are as follows:

ACR	American college of Radiology
ANSI	American National Standards Institute
AE	Application Entity
CD/DVD	MARS can be configured with CD only, DVD only or a combination CD/DVD drive
CD-R	Compact disk recordable
DICOM	Digital Imaging and Communications in Medicine
DIMSE	DICOM Message Service Element
DIMSE-C	DICOM Message Service Element-Composite
DIMSE-N	DICOM Message Service Element-Normalized
DVD-R	Digital video disk recordable
DVD+R	Digital video disk recordable
FSC	File Set Creator
FSR	File Set Reader
FSU	File Set Updater
NEMA	National Electrical Manufacturers Association
PDU	Protocol Data Unit
RWA	Real World Activity
SCP	Service Class Provider
MPPS	Modality Performed Procedure Step
MWL	Modality Worklist
SCP	Service Class Provider
SCU	Service Class User
SOP	Service-Object Pair
TCP/IP	Transmission Control Protocol/Internet Protocol
UID	Unique Identifier



## 3 Networking

### 3.1 Implementation Model

MARS networking is implemented in one Application Entity.

#### 3.1.1 *Application Data flow*

As depicted in Figure 3.1.1-1, the MARS incorporates the following functionalities:

- After RWA Request Verification, the MARS AE as SCP provides standard Verification Service Class functionality to the requesting SCU.
- After RWA Store Images, the MARS AE as SCP provides standard Storage Service Class functionality to the requesting SCU
- After operator RWA Find Remote Images, the MARS AE as SCU uses the remote SCP Query/Retrieve Service Class functionality to query/move remote images.

**Figure 3.1.1-1: Application Data Flow**

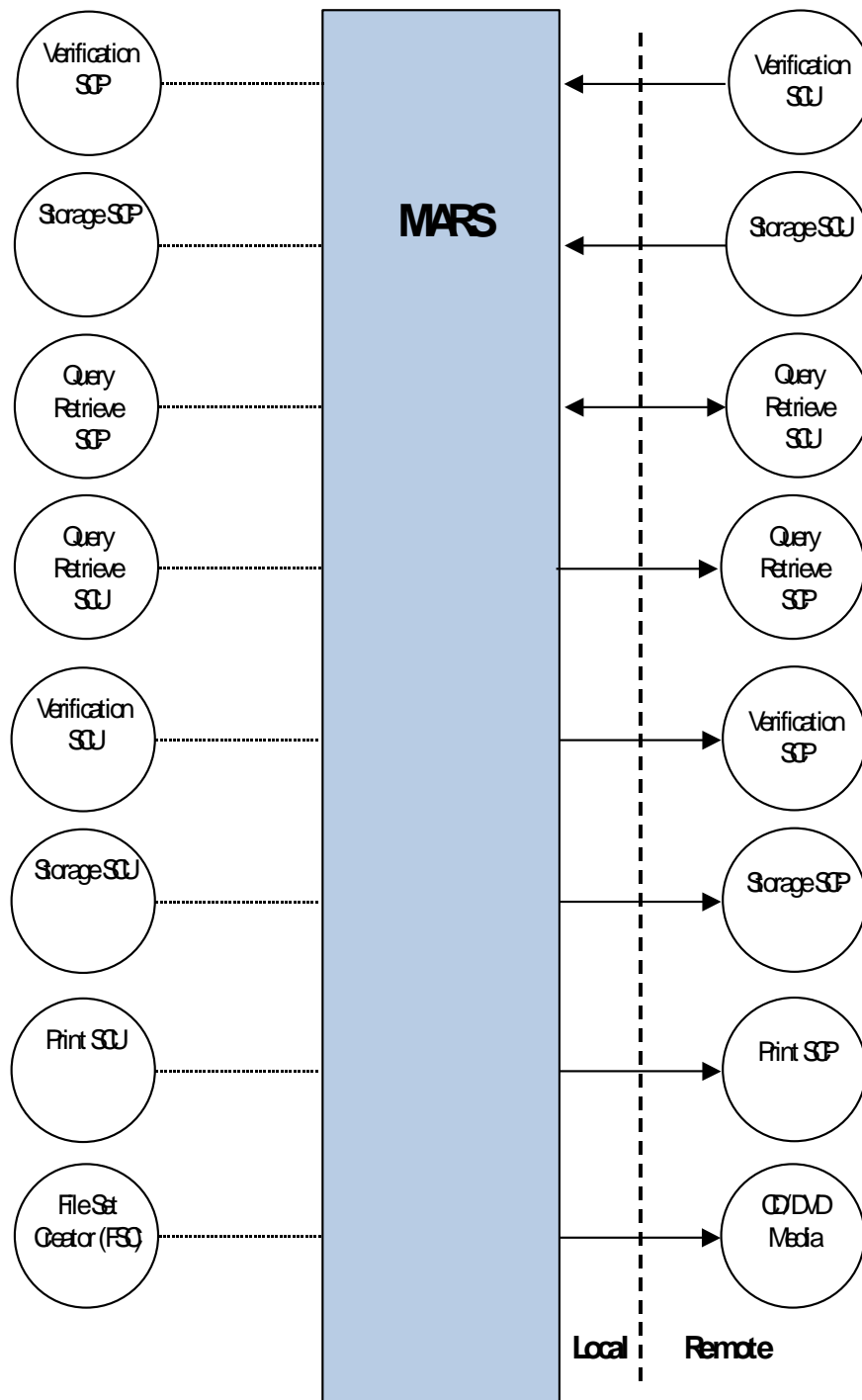

After installing MARS, the software administrator will use MARS settings interface to declare the DICOM peers that MARS will communicate with. These peers may include Modalities/Stations and PACS (DICOM Store and Query & Retrieve).

At installation or whenever a problem occurs, the network communication between MARS and other DICOM peers can be checked within the Verification service. This operation can be performed from within *MARS Web interface* as well as from other applications.

MARS stores in its database DICOM datasets received from Storage applications.

When MARS receives Query requests from other DICOM applications, it searches for matching items in its database and returns the resulting list.

### **3.1.2 Functional Definitions of the Application Entity**

#### **3.1.2.1 Verification Service as SCU**

On user demand, MARS can initiate associations with Presentation Contexts for the Verification service SOP class. It will send a C-ECHO request to another DICOM application and wait for a response to complete the verification.

#### **3.1.2.2 Verification Service as SCP**

As a Verification SCP, MARS waits for another application to connect at the presentation address configured for its Application Entity Title. When another application connects, MARS expects it to be a DICOM application. MARS will accept associations with Presentation Contexts for the Verification service SOP class. If MARS receives a C-ECHO request from another DICOM Application, it will return a C-ECHO response.

#### **3.1.2.3 Image Storage Service as SCU**

To store local images, MARS establishes an association with a remote Storage SCP, negotiates its presentation contexts according to images SOP Classes and their native transfer syntax, and sends all images.

Then MARS closes the association.

#### **3.1.2.4 Image Storage Service as SCP**

As an Image Storage SCP, MARS waits for another application to connect at the presentation address configured for its Application Entity Titles. When another application connects, MARS expects it to be a DICOM application. MARS will accept associations with Presentation Contexts for SOP Classes of the Storage Service Class. It will receive images on these Presentation Contexts and will write them to files in the format compliant to Part 10 of the DICOM standard. It will also reference those images in its database.

#### **3.1.2.5 Query and Retrieve Service as SCU**

MARS query and retrieve policy is the following:

For each C\_FIND or C\_MOVE operation, an association is negotiated with a remote Query and Retrieve SCP. When the association is successfully negotiated, MARS performs requests depending of its context (Information model, filters). MARS then waits for query results.

Retrieve operation can be performed only on MARS local AETitles.

#### **3.1.2.6 Query and Retrieve Service as SCP**

MARS will accept associations with Presentation Contexts for Find and Move service classes using Study Root Information Model. It will respond to query and retrieve requests on these Presentation Contexts. MARS will use the content of its database to fulfill the request.



Revision: 12  
Date: June 2016

### **3.1.2.7 Color / Grayscale Printing Service as SCU**

MARS may use the Print services to print films to DICOM printers.  
MARS establishes one association with the remote Print SCP, performs its print request and closes the association when printing is done, successfully or not.

### **3.1.2.8 File Set Creator (FSC)**

MARS allows user to write on CD/DVD a set of studies .

### **3.1.3 Sequencing of Real-Word Activities**

Real-World Activity for Verification SCU/SCP operations is independent of other operations.  
Real-World Activity for Storage SCU/SCP operations is independent of other operations.  
Real-World Activity for Query and Retrieve SCU/SCP operations is independent of other operations.  
Real-World Activity for Print SCU operations is independent of other operations.



## 3.2 Application Entity Specifications

### 3.2.1 SOP Classes

MARS AE provides Standard Conformance to the following DICOM V3.0 SOP Classes:

**Table 3.2.1-1: SOP Classes for MARS AE**

SOP Class Name	SOP Class UID	SCU	SCP
<b>Supported SOP Classes for Verification</b>			
Verification	1.2.840.10008.1.1	Yes	Yes
<b>Supported SOP Classes for Storage</b>			
Computed Radiography Image Storage	1.2.840.10008.5.1.4.1.1.1	Yes	Yes
Digital XRay Image Storage For Presentation	1.2.840.10008.5.1.4.1.1.1.1	Yes	Yes
Digital XRay Image Storage For Processing	1.2.840.10008.5.1.4.1.1.1.1.1	Yes	Yes
Digital Mammography Xray Image Storage For Presentation	1.2.840.10008.5.1.4.1.1.1.2	Yes	Yes
Digital Mammography Xray Image Storage For Processing	1.2.840.10008.5.1.4.1.1.1.2.1	Yes	Yes
Digital Intra Oral XRay Image Storage For Presentation	1.2.840.10008.5.1.4.1.1.1.3	Yes	Yes
Digital Intra Oral XRay Image Storage For Processing	1.2.840.10008.5.1.4.1.1.1.3.1	Yes	Yes
CT Image Storage	1.2.840.10008.5.1.4.1.1.2	Yes	Yes
Enhanced CT Image Storage	1.2.840.10008.5.1.4.1.1.2.1	Yes	Yes
<i>US Multiframe Image Storage (RET)</i>	1.2.840.10008.5.1.4.1.1.3	Yes	Yes
US Multiframe Image Storage	1.2.840.10008.5.1.4.1.1.3.1	Yes	Yes
MR Image Storage	1.2.840.10008.5.1.4.1.1.4	Yes	Yes
Enhanced MR Image Storage	1.2.840.10008.5.1.4.1.1.4.1	Yes	Yes
MR Spectroscopy Storage	1.2.840.10008.5.1.4.1.1.4.2	Yes	Yes
<i>NM Image Storage (RET)</i>	1.2.840.10008.5.1.4.1.1.5	Yes	Yes
<i>US Image Storage (RET)</i>	1.2.840.10008.5.1.4.1.1.6	Yes	Yes
US Image Storage	1.2.840.10008.5.1.4.1.1.6.1	Yes	Yes
Secondary Capture Image Storage	1.2.840.10008.5.1.4.1.1.7	Yes	Yes





Revision: 12  
Date: June 2016

SOP Class Name	SOP Class UID	SCU	SCP
Multiframe Secondary Capture Single Bit Image Storage	1.2.840.10008.5.1.4.1.1.7.1	Yes	Yes
Multiframe Secondary Capture Byte Image Storage	1.2.840.10008.5.1.4.1.1.7.2	Yes	Yes
Multiframe Secondary Capture Word Image Storage	1.2.840.10008.5.1.4.1.1.7.3	Yes	Yes
Multiframe Secondary Capture True Color Image Storage	1.2.840.10008.5.1.4.1.1.7.4	Yes	Yes
Twelve Lead ECG Waveform Storage	1.2.840.10008.5.1.4.1.1.9.1.1	Yes	Yes
General ECG Waveform Storage	1.2.840.10008.5.1.4.1.1.9.1.2	Yes	Yes
Ambulatory ECG Waveform Storage	1.2.840.10008.5.1.4.1.1.9.1.3	Yes	Yes
Hemodynamic Waveform Storage	1.2.840.10008.5.1.4.1.1.9.2.1	Yes	Yes
Cardiac Electrophysiologic Audio Waveform Storage	1.2.840.10008.5.1.4.1.1.9.3.1	Yes	Yes
Basic Voice Audio Waveform Storage	1.2.840.10008.5.1.4.1.1.9.4.1	Yes	Yes
Grayscale Softcopy Presentation State Storage	1.2.840.10008.5.1.4.1.1.11.1	Yes	Yes
XRay Angiographic Image Storage	1.2.840.10008.5.1.4.1.1.12.1	Yes	Yes
XRay Fluoroscopy Image Storage	1.2.840.10008.5.1.4.1.1.12.2	Yes	Yes
<i>XRay Angiographic BiPlane Image Storage (RET)</i>	1.2.840.10008.5.1.4.1.1.12.3	Yes	Yes
Xray 3D Angiographic Image Storage	1.2.840.10008.5.1.4.1.1.13.1.1	Yes	Yes
Xray 3D Craniofacial Image Storage	1.2.840.10008.5.1.4.1.1.13.1.2	Yes	Yes
NM Image Storage	1.2.840.10008.5.1.4.1.1.20	Yes	Yes
RT Image Storage	1.2.840.10008.5.1.4.1.1.481.1	Yes	Yes
RT Dose Storage	1.2.840.10008.5.1.4.1.1.481.2	Yes	Yes
RT Structure Set Storage	1.2.840.10008.5.1.4.1.1.481.3	Yes	Yes
RT Beams Treatment Record Storage	1.2.840.10008.5.1.4.1.1.481.4	Yes	Yes
RT Plan Storage	1.2.840.10008.5.1.4.1.1.481.5	Yes	Yes
RT Brachy Treatment Record Storage	1.2.840.10008.5.1.4.1.1.481.6	Yes	Yes
RT Treatment Summary Record Storage	1.2.840.10008.5.1.4.1.1.481.7	Yes	Yes
PET Image Storage	1.2.840.10008.5.1.4.1.1.128	Yes	Yes
PET Curve Storage	1.2.840.10008.5.1.4.1.1.129	Yes	Yes



Revision: 12  
Date: June 2016

SOP Class Name	SOP Class UID	SCU	SCP
Stored Print Storage	1.2.840.10008.5.1.1.27	Yes	Yes
Hardcopy Grayscale Image Storage	1.2.840.10008.5.1.1.29	Yes	Yes
Hardcopy Color Image Storage	1.2.840.10008.5.1.1.30	Yes	Yes
Raw Data Storage	1.2.840.10008.5.1.1.66	Yes	Yes
Spatial Registration Storage	1.2.840.10008.5.1.1.66.1	Yes	Yes
Spatial Fiducial Storage	1.2.840.10008.5.1.1.66.2	Yes	Yes
VL Endoscopic Image Storage	1.2.840.10008.5.1.4.1.1.77.1.1	Yes	Yes
Video Endoscopic Image Storage	1.2.840.10008.5.1.4.1.1.77.1.1.1	Yes	Yes
VL Microscopic Image Storage	1.2.840.10008.5.1.4.1.1.77.1.2	Yes	Yes
Video Microscopic Image Storage	1.2.840.10008.5.1.4.1.1.77.1.2.1	Yes	Yes
VL Slide Coordinates Microscopic Image Storage	1.2.840.10008.5.1.4.1.1.77.1.3	Yes	Yes
VL Photographic Image Storage	1.2.840.10008.5.1.4.1.1.77.1.4	Yes	Yes
Video Photographic Image Storage	1.2.840.10008.5.1.4.1.1.77.1.4.1	Yes	Yes
Ophthalmic Photography 8Bit Image Storage	1.2.840.10008.5.1.4.1.1.77.1.5.1	Yes	Yes
Ophthalmic Photography 16Bit Image Storage	1.2.840.10008.5.1.4.1.1.77.1.5.2	Yes	Yes
Stereometric Relationship Storage	1.2.840.10008.5.1.4.1.1.77.1.5.3	Yes	Yes
Ophthalmic Tomography Image Storage	1.2.840.10008.5.1.4.1.1.77.1.5.4	Yes	Yes
Basic Text SR	1.2.840.10008.5.1.4.1.1.88.11	Yes	Yes
Enhanced SR	1.2.840.10008.5.1.4.1.1.88.22	Yes	Yes
Comprehensive SR	1.2.840.10008.5.1.4.1.1.88.33	Yes	Yes
Procedure Log Storage	1.2.840.10008.5.1.4.1.1.88.40	Yes	Yes
Mammography CADSR	1.2.840.10008.5.1.4.1.1.88.50	Yes	Yes
Key Object Selection Document	1.2.840.10008.5.1.4.1.1.88.59	Yes	Yes
Chest CADSR	1.2.840.10008.5.1.4.1.1.88.65	Yes	Yes
Encapsulated PDF Storage	1.2.840.10008.5.1.4.1.1.104.1	Yes	Yes
Encapsulated CDA Storage	1.2.840.10008.5.1.4.1.1.104.2	Yes	Yes



SOP Class Name	SOP Class UID	SCU	SCP
Private Fuji CR Image Storage	1.2.392.200036.9125.1.1.2	Yes	Yes
PrivateToshiba Raw Data Storage	1.2.392.200036.9116.7.8.1.1.1	Yes	Yes
<b>Supported SOP Class For Query and Retrieve</b>			
Study Root Query/Retrieve Information Model – FIND	1.2.840.10008.5.1.4.1.2.2.1	Yes	Yes
Study Root Query/Retrieve Information Model – MOVE	1.2.840.10008.5.1.4.1.2.2.2	Yes	Yes
<b>Supported Meta SOP Class for Basic Print SCU</b>			
Basic Grayscale Print Management	1.2.840.10008.5.1.1.9	Yes	No
Basic Color Print Management	1.2.840.10008.5.1.1.18	Yes	No
<b>Supported Meta SOP Class for Basic Grayscale Print SCU</b>			
Basic Film Session SOP Class	1.2.840.10008.5.1.1.1	Yes	No
Basic Film Box SOP Class	1.2.840.10008.5.1.1.2	Yes	No
Basic Grayscale Image Box SOP Class	1.2.840.10008.5.1.1.4	Yes	No
Printer SOP Class	1.2.840.10008.5.1.1.16	Yes	No
<b>Supported Meta SOP Class for Basic Color Print SCU</b>			
Basic Film Session SOP Class	1.2.840.10008.5.1.1.1	Yes	No
Basic Film Box SOP Class	1.2.840.10008.5.1.1.2	Yes	No
Basic Color Image Box SOP Class	1.2.840.10008.5.1.1.4.1	Yes	No
Printer SOP Class	1.2.840.10008.5.1.1.16	Yes	No

### 3.2.2 Association Policies

#### 3.2.2.1 General

MARS contains the following limitations for PDU size:

Minimum PDU size	8,192 bytes
<i>Maximum PDU size</i>	<i>16,384 bytes</i>

#### 3.2.2.2 Number of Associations

**Table 3.2.2.2-1: Number of Associations as an Association Initiator for MARS AE**

Maximum number of simultaneous associations	Up to number of MARS users +2
---	-------------------------------

Move operation are performed in background.

Print operation are performed in background.

Simultaneous Find or store operation depends of number of users ( 1 on Basic edition and 50 with Advanced edition).

**Table 3.2.2.2-2: Number of Associations as an Association Acceptor for MARS AE**

Maximum number of simultaneous associations	Up to 5 simultaneous associations *
---	--

MARS can be configured to accept associations from any AE Title or only from known (declared) AE Title. In this case, associations from unknown AE Titles will be rejected. Additionally, MARS may be configured to propose only the presentation contexts that are relevant to the services (Store SCU and/or Query/Retrieve SCU) declared for the AE-Title.

*\* can be configured.*

#### 3.2.2.3 Asynchronous Nature

MARS AE does not support asynchronous communication (multiple outstanding transactions over a single association).

Maximum number of outstanding asynchronous transactions	N/A
---	-----

#### 3.2.2.4 Implementation Identifying Information

The implementation information for the Application Entity is:

**Table 3.2.2.4-1: DICOM Implementation Class and Version for MARS AE**

Implementation class UID	1.2.250.1.59.3.0.3.5.3
Application Context Name	1.2.840.10008.3.1.1.1
Implementation version name	ETIAM_DCMTK_353

### 3.2.2.5 Association Initiation Policy

MARS initiates an association for implementing the following services as SCUs:

- \_ Verification
- \_ Query and Retrieve
- \_ Storage
- \_ Basic Print Management

#### 3.2.2.5.1 Activity – Verification SCU

##### 3.2.2.5.1.1 Description and Sequencing of Activities

MARS will initiate an association with a Verification SCP within the Configuration panel to check SCP availability.

Association is then opened, negotiated and closed synchronously.

**Figure 3.2.2.5.1.1-1: Sequencing of Activity – Verification**

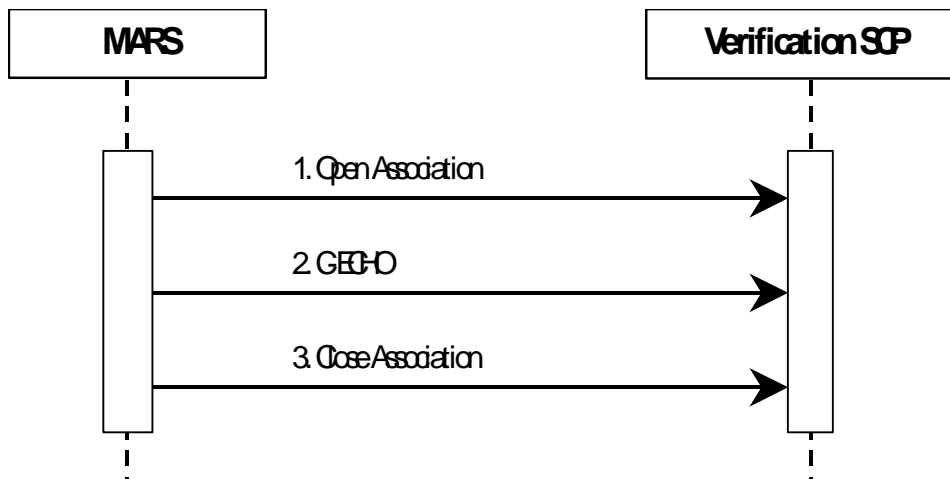

### 3.2.2.5.1.2 Proposed Presentation Contexts

**Table 3.2.2.5.1.2-1: Proposed Presentation Contexts for MARS AE and Verification Activity**

Presentation Context Table					
Abstract Syntax		Transfer Syntax		Role	Extended Negotiation
Name	UID	Name List	UID List		
Verification	1.2.840.10008.1.1	Implicit VR Little Endian	1.2.840.10008.1.2	SCU	None

### 3.2.2.5.1.3 SOP Specific Conformance to the Verification SOP Class

MARS provides standard conformance to the DICOM Verification Service Class as a SCU. The status code for the C-ECHO is shown in the following table:

**Table 3.2.2.5.1.3-1: C-ECHO Response Status Handling Behaviour**

Code	Status	Meaning
0000	Success	The C-ECHO request is accepted.

**Table 3.2.2.5.1.3-2: C-ECHO Communication Failure Behaviour**

Exception	Behaviour
Timeout	The Association is aborted using A-ABORT.
Other errors	

### 3.2.2.5.2 Activity – Storage SCU

#### 3.2.2.5.2.1 Description and Sequencing of Activities

MARS will initiate an association with a Storage SCP to store all images. All images will be stored on an association.

**Figure 3.2.2.5.2.1-1: Sequencing of Activity – Storage**

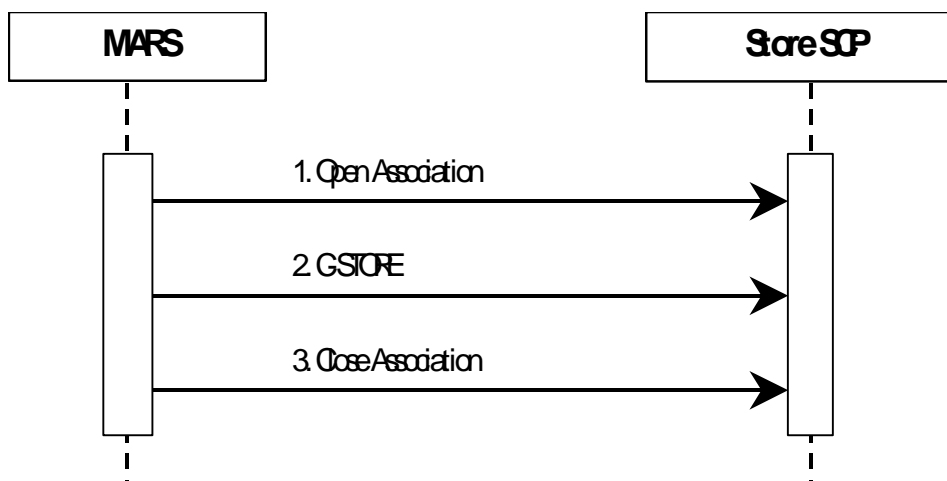

#### 3.2.2.5.2.2 Proposed Presentation Contexts

**Table 3.2.2.5.2.2-1: Proposed Presentation Contexts for MARS AE and Store Activity**

Presentation Context Table				
Abstract Syntax	Transfer Syntax		Role	Extended Negotiation
See note below	Name List	UID List		
	Implicit VR Little Endian	1.2.840.10008.1.2	SCU	None
	Explicit VR Little Endian	1.2.840.10008.1.2.1	SCU	None
	Explicit VR Big Endian	1.2.840.10008.1.2.2	SCU	None



Presentation Context Table				
	JPEG Baseline : Default Transfer Syntax for Lossy JPEG 8 Bit Image Compression	1.2.840.10008.1.2.4.5 0	SCU	None
	JPEG Extended (Process 2 & 4): Default Transfer Syntax for Lossy JPEG 12 Bit Image Compression	1.2.840.10008.1.2.4.5 1	SCU	None
	JPEG Lossless, Non-Hierarchical, First-Order Prediction	1.2.840.10008.1.2.4.7 0	SCU	None
	JPEG 2000 Lossless	1.2.840.10008.1.2.4.9 0	SCU	None
	JPEG 2000	1.2.840.10008.1.2.4.9 1	SCU	None
	MPEG2 Main Profile @ Main Level	1.2.840.10008.1.2.4.1 00	SCU	None
	MPEG2 Main Profile @ High Level	1.2.840.10008.1.2.4.1 01	SCU	None
	RLE Lossless	1.2.840.10008.1.2.5	SCU	None

**Note:** Transfer syntaxes referenced in the above table applies to a very large number of Storage Abstract Syntax.

The abstract syntaxes names and UIDs are listed in Table 3.2.2.5.1.2-1.

MARS applies the following rules for its proposed presentation contexts;

- All uncompressed transfer syntaxes are proposed for Storage operations.
- If an image is encoded, its corresponding native transfer syntax is proposed also, and will be preferred by SCU if both compressed and uncompressed transfer syntaxes are accepted by SCP.
- If SCP does not accept encoded transfer syntaxes, MARS will uncompress the related images on the fly.

### 3.2.2.5.3 Activity – Print SCU

#### 3.2.2.5.3.1 Description and Sequencing of Activities

MARS will initiate a separate association with a Print SCP for each print session.





After an association has been accepted and is established, MARS will send a print job to the Print Server. Each

print job includes the following steps:

- MARS first performs a N-GET request to get Printer information.
- MARS requests the server to a N-CREATE a film session SOP instance.

For each film to be printed:

- a N-CREATE request is performed to get a Film Box SOP instance
- N-SET requests are made to change some film box instance attributes and to fill image boxes with image pixel data.
- if no print collation is needed, an N-ACTION is requested for the Film Box instance. This causes the film to be printed.
- If print collation is requested, an N-ACTION is performed on the film session.

### 3.2.2.5.3.2 Proposed Presentation Contexts

**Table 3.2.2.5.3.2-1: Proposed Presentation Contexts for MARS AE and Print Activity**

<b>Presentation Context Table</b>					
<b>Abstract Syntax</b>		<b>Transfer Syntax</b>		<b>Role</b>	<b>Extended Negotiation</b>
<b>Name</b>	<b>UID</b>	<b>Name List</b>	<b>UID List</b>		
Basic Grayscale Print Management Meta SOP Class	1.2.840.10008.5.1.1.9	Implicit VR Little Endian	1.2.840.10008.1.2	SCP	None
Basic Color Print Management Meta SOP Class	1.2.840.10008.5.1.1.9	Implicit VR Little Endian	1.2.840.10008.1.2	SCP	None

### 3.2.2.5.3.3 SOP Specific Conformance to the Print SOP Class

If the MARS software is unable to open an association with the selected destination AE, the job report qn error message. No message is reported when successful printing operation responses are received.

#### 3.2.2.5.3.3.1 Basic Film Session SOP Class

MARS can send the following DIMSE commands:

- N-CREATE
- N-SET
- N-ACTION

**N-CREATE** is issued by MARS to create a Film Session where film boxes will be created.

Attribute Name	Tag	Value / Comment
Number of copies	(2000, 0010)	Default is 1

**N-SET** is issued by MARS to change Film Session attributes.

Attribute Name	Tag	Value / Comment
Number of copies	(2000, 0010)	Default is 1
Print Priority	(2000, 0020)	HIGH, MED, LOW. Default is MED
Medium Type	(2000, 0030)	PAPER, BLUE FILM, CLEAR FILM, empty string
Film Destination	(2000, 0040)	PROCESSOR or MAGAZINE. Not set if default.
Film Session Label	(2000, 0050)	Default is MARS

**N-ACTION** is issued by MARS to request printing of all Film Boxes in the Film Session.

#### 3.2.2.5.3.3.2 Basic Film Box SOP Class

MARS can send the following DIMSE commands:

- N-CREATE
- N-SET
- N-ACTION

**N-CREATE** is issued by MARS to create a Film Box in a Film Session.

Attribute Name	Tag	Value / Comment
Image Display Format	(2000, 0010)	STANDARD
Film Orientation	(2010, 0030)	PORTRAIT or LANDSCAPE. Not set if default.

**N-SET** is issued by MARS to change Film Session attributes.

Attribute Name	Tag ID	Value / Comment
Image Display Format	(2010, 0010)	STANDARD
Film Orientation	(2010, 0030)	PORTRAIT or LANDSCAPE. Not set if default.
Film Size ID	(2010, 0060)	8INX10IN, 10INX12IN, 10INX14IN, 11INX14IN, , 14INX14IN, 14INX17IN, 24CMX24CM, 24CMX30CM, A4 or A3. Not set if default.
Magnification Type	(2010, 0060)	REPLICATE, BILINEAR or CUBIC Not set if default.
Smoothing Type	(2010, 0080)	Not set if default.
Border Density	(2010, 0100)	Not set if default
Empty Image Density	(2010, 0110)	Not set if default
Min Density	(2010, 0120)	Not set if default
Max Density	(2010, 0130)	Not set if default
Trim	(2010, 0140)	Not set if default
Referenced Film Session Sequence	(2010, 0500)	
>Referenced SOP Class UID	(0008, 1150)	

Attribute Name	Tag ID	Value / Comment
>Referenced SOP Instance UID	(0008, 1155)	

**N-ACTION** is issued by MARS to request printing.

### 3.2.2.5.3.3.3 Basic Grayscale Image Box SOP Class

Basic Grayscale Image Box instances are created at the time the Basic Film Box SOP instance is created (N-CREATE). The Basic Image Box contains the presentation parameters and image pixel data that applies to a single image of a film sheet.

MARS can send the following DIMSE command:

N-SET

**N-SET** is issued by MARS to set Image Box attributes.

Attribute Name	Tag ID	Value / Comment
Image Position	(2020, 0010)	1 to <number of images in film box>
Polarity	(2020, 0020)	NORMAL or REVERSE. Not set if default.
Basic Grayscale Image Sequence	(2020, 0110)	
>Samples Per Pixel	(0028, 0002)	3
>Photometric Interpretation	(0028, 0004)	MONOCHROME2
>Rows	(0028, 0010)	
>Columns	(0028, 0011)	
>Pixel Aspect Ratio	(0028, 0034)	1\1
>Bits Allocated	(0028, 0100)	8 or 16

Attribute Name	Tag ID	Value / Comment
>Bits Stored	(0028, 0101)	8 or 12
>High Bit	(0028, 0102)	7 or 11
>Pixel Representation	(0028, 0103)	0
>Pixel Data	(7FE0, 0010)	

#### 3.2.2.5.3.3.4 Basic Color Image Box SOP Class

Basic Color Image Box instances are created at the time the Basic Film Box SOP instance is created (N-CREATE). The Basic Image Box contains the presentation parameters and image pixel data that apply to a single image of a film page.

MARS can send the following DIMSE command:

N-SET

**N-SET** is issued by MARS to set Image Box attributes.

Attribute Name	Tag ID	Value / Comment
Image Position	(2020, 0010)	1 to <number of images in film box>
Polarity	(2020, 0020)	NORMAL or REVERSE. Not set if default.
Basic Color Image Sequence	(2020, 0110)	
>Samples Per Pixel	(0028, 0002)	3
>Photometric Interpretation	(0028, 0004)	RGB
>Planar Configuration	(0028, 0006)	0
>Rows	(0028, 0010)	



Attribute Name	Tag ID	Value / Comment
>Columns	(0028, 0011)	
>Pixel Aspect Ratio	(0028, 0034)	1\1
>Bits Allocated	(0028, 0100)	8
>Bits Stored	(0028, 0101)	8
>High Bit	(0028, 0102)	7
>Pixel Representation	(0028, 0103)	0
>Pixel Data	(7FE0, 0010)	

### 3.2.2.5.3.3.5 Basic Printer SOP Class

MARS can send the following DIMSE command:

N-GET

**N-GET** is issued by MARS to get Printer information. However, this information is not used.

### 3.2.2.5.4 Activity – Query Remote Images

#### 3.2.2.5.4.1 Description and Sequencing of Activities

The operator queries a remote database by means of the query tool in the Interface. The MARS AE initiates an association with a remote Query and Retrieve SCP. When the association is successfully negotiated, MARS performs requests depending of its context (Information model, filters). MARS then waits for query responses and displays them on the MARS interface.

**Figure 3.2.2.5.4.1-1: Sequencing of Activity – Query Remote Images**

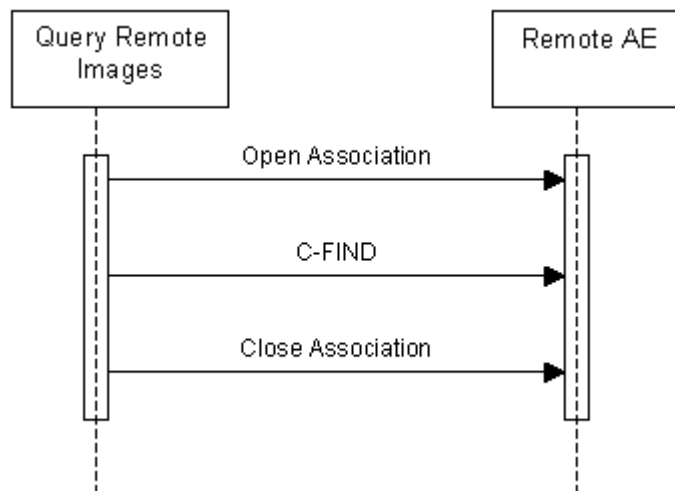

#### 3.2.2.5.4.2 Proposed Presentation Contexts

**Table 3.2.2.5.4.2-1: Proposed Presentation Contexts for MARS AE and Print Activity**

Presentation Context Table					
Abstract Syntax		Transfer Syntax		Role	Extended Negotiation
Name	UID	Name List	UID List		
Study Root Find	1.2.840.10008.5.1 .4.1.2.2.1	Implicit VR Little Endian	1.2.840.10008.1.2	SCP	None



3.2.2.5.4.3 SOP Specific Conformance for Study Root Find SOP Class

In the following table the supported query keys for Study query level are described.

**Table 3.2.2.5.4.3-1: Study Root Find SOP Class query attributes**

Attribute Name	Tag	Level	Type of Matching
PatientName	(0010,0010)	Study	Wildchar / Single Value/ Universal
PatientID	(0010,0020)	Study	Wildchar / Single Value / Universal
PatientBirthDate	(0010,0030)	Study	Single Value / Universal
PatientSex	(0010,0040)	Study	Single Value / Universal
StudyInstanceUID	(0020,000D)	Study	Single Value / Universal
Study Date	(0008,0020)	Study	Range / Universal
Study Time	(0008,0030)	Study	Universal
Accession Number	(0008,0050)	Study	Universal
ReferringPhysiciansName	(0008,0090)	Study	Universal
NameOfPhysiciansReadingStudy	(0008,0090)	Study	Universal
StudyDescription	(0008,1030)	Study	Wildchar / Universal
StudyID	(0020,0010)	Study	Wildchar / Single Value / Universal
SeriesInstanceUID	(0020,000E)	Series	Single Value / Universal
Modality	(0008,0060)	Series	Universal
SeriesNumber	(0020,0011)	Series	Universal
SOPInstanceUID	(0008,0018)	Image	Single Value / Universal



**Table3.2.2.5.4.3-1: Study Root Find Response Status Handling Behavior**

Service Status	Further Meaning	Error Code	Behavior
Success	Matching is complete	0000	The result is displayed on the web browser.
Cancel	Matching terminated due to Cancel request	FE00	No result is displayed
Pending	Matches are continuing – Current match is supplied and any Optional Keys were supported in the same manner as Required Keys.	FF00	No result is displayed.
	Matches are continuing – Warning that one or more Optional Keys were not supported for existence and/or matching for this Identifier.	FF01	No result is displayed
Failure	Refused: out of resources	A700	No result is displayed. The reason is reported to the user.
	Identifier does not match SOP Class	A900	No result is displayed. The reason is reported to the user.

### 3.2.2.5.5 Activity – Retrieve Remote Images

#### 3.2.2.5.5.1 Description and Sequencing of Activities

The operator is able to retrieve the selected images from a remote database by creating a writing job from MARS Interface. For each Retrieve (C\_MOVE) request, an association is negotiated with a remote Query and Retrieve SCP. When the association is successfully negotiated, MARS performs requests depending of its context (Information model, filters). MARS then waits for query results and write them.

**Figure 3.2.2.5.5.1-1: Sequencing of Activity – Retrieve Remote Images**

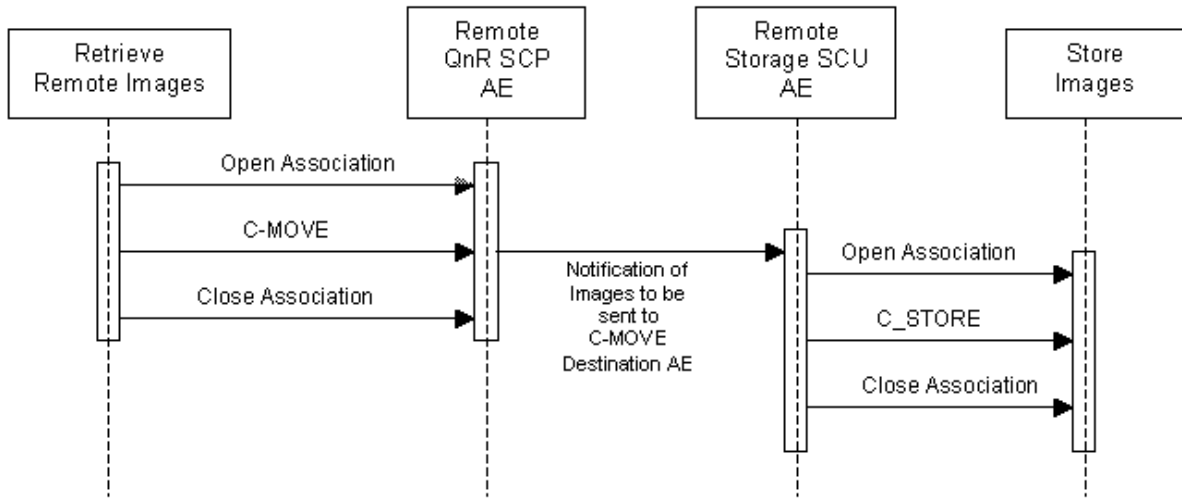

3.2.2.5.5.2 Proposed Presentation Contexts

**Table 3.2.2.5.5.2-1: Proposed Presentation Contexts for MARS AE and Retrieve Remote Images Activity**

Presentation Context Table						
Abstract Syntax			Transfer Syntax		Role	Extended Negotiation
Name	UID		Name List	UID List		
Study Move	Root	1.2.840.10008.5.1.4.1.2.2.2	Implicit VR Little Endian	1.2.840.10008.1.2	SCP	None



3.2.2.5.5.3 SOP Specific Conformance for Study Root Move SOP Class

**Table 3.2.2.5.5.3-1: Study Root Move Response Status Handling Behavior**

Service Status	Further Meaning	Error Code	Behavior
Success	Sub-operations Complete – No Failures	0000	The selected SOP Instances are sent to the MARS AE Title.
Pending	Sub-operations are continuing	FF00	No particular behavior
Warning	Sub-operations complete. One or more Failures	FE00	No particular behavior
Cancel	Sub-operations terminated due to a Cancel indication	B000	No particular behavior
Failure	Refused: Out of resources – Unable to calculate number of matches	A701	The reason is reported to the user.
	Refused: Out of Resources – Unable to perform sub-operations	A702	The reason is reported to the user.
	Refused: Move destination unknown	A801	The reason is reported to the user.
	Identifier does not match SOP Class	A900	The reason is reported to the user.

### 3.2.2.6 Association Acceptance Policy

MARS will accept associations as long as the maximum number of associations is not reached. If the maximum number of associations is reached, the association is rejected.

#### 3.2.2.6.1 Activity – Verification

##### 3.2.2.6.1.1 Description and Sequencing of Activities

MARS will accept associations from systems that want to verify application-level communication using the C-ECHO command.

**Figure 3.2.2.6.1.1-1: Sequencing of Activity – Verification**

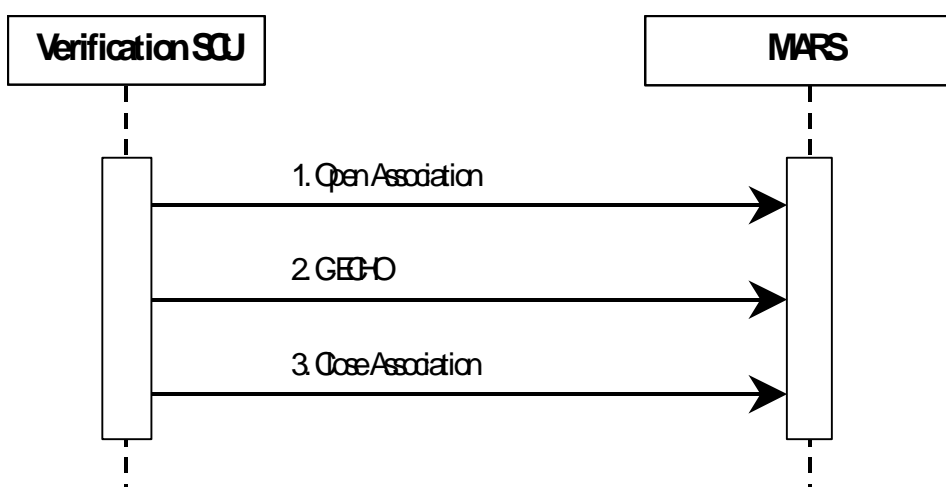

Under normal circumstances the sequencing depicted above applies:

1. The modality opens an association with MARS
2. It sends a C-ECHO request to MARS
3. It closes the association

##### 3.2.2.6.1.2 Accepted Presentation Contexts

**Table 3.2.2.6.1.2-1: Acceptable Presentation Contexts for MARS AE and Verification Activity**

Presentation Context Table					
Abstract Syntax		Transfer Syntax		Role	Extended Negotiation
Name	UID	Name List	UID List		
Verification	1.2.840.10008.1.1	Implicit VR Little Endian	1.2.840.10008.1.2	SCP	None

### 3.2.2.6.1.3 SOP Specific Conformance to Verification SOP Class

MARS provides standard conformance to the DICOM Verification Service Class as a SCP. The status code for the C-ECHO is shown in the following table:

**Table 3.2.2.6.1.3-1: C-ECHO Response Status Handling Reason**

Code	Status	Reason
0000	Success	The C-ECHO request is accepted.

### 3.2.2.6.2 Activity Storage

#### 3.2.2.6.2.1 Description and Sequencing of Activities

MARS AE will accept associations from systems that want to store datasets in the MARS database using C-STORE commands.

**Figure 3.2.2.6.2.1-1: Sequencing of Activity – Storage**

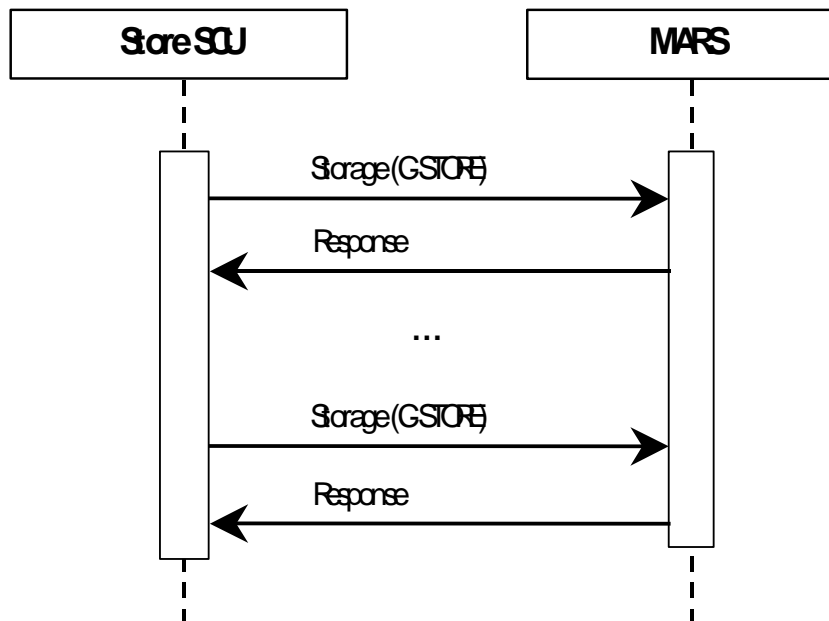

The figure above is a typical sequence of messages between a Store SCU and MARS:

### 3.2.2.6.2.2 Accepted Presentation Contexts

**Table 3.2.2.6.2.2-1: Acceptable Presentation Contexts for MARS AE and Storage Activity**

Presentation Context Table				
Abstract Syntax	Transfer Syntax		Role	Extended Negotiation
See note below	Implicit VR Little Endian	1.2.840.10008.1.2	SCP	None
	Explicit VR Little Endian	1.2.840.10008.1.2.1	SCP	None
	Explicit VR Big Endian	1.2.840.10008.1.2.2	SCP	None
	JPEG Baseline : Default Transfer Syntax for Lossy JPEG 8 Bit Image Compression	1.2.840.10008.1.2.4.50	SCP	None
	JPEG Extended (Process 2 & 4): Default Transfer Syntax for Lossy JPEG 12 Bit Image Compression	1.2.840.10008.1.2.4.51	SCP	None
	JPEG Lossless, Non-Hierarchical, First-Order Prediction	1.2.840.10008.1.2.4.70	SCP	None
	JPEG 2000 Lossless	1.2.840.10008.1.2.4.90	SCP	None
	JPEG 2000	1.2.840.10008.1.2.4.91	SCP	None
	MPEG2 Main Profile @ Main Level	1.2.840.10008.1.2.4.100	SCP	None
	MPEG2 Main Profile @ High Level	1.2.840.10008.1.2.4.101	SCP	None
	RLE Lossless	1.2.840.10008.1.2.5	SCP	None

**Note:** Transfer syntaxes referenced in the above table applies to a very large number of Storage Abstract Syntax. The abstract syntaxes names and UIDs are listed in **Erreur ! Source du renvoi introuvable.**

### 3.2.2.6.2.3 SOP Specific Conformance to Query and Retrieve SOP Class

MARS provides standard conformance to the DICOM Storage Service Class.

No control is made concerning the Abstract/Transfer syntax consistency.

MARS will prefer, for storage operations, in decreasing order:

- Encoded transfer syntax
- Explicit VR Little Endian transfer syntax
- Implicit VR Little Endian transfer syntax
- Explicit VR Big Endian transfer syntax

**Table 3.2.2.6.2.3-1: Storage C-STORE Response Status Handling Behavior**

Service Status	Further Meaning	Error Code	Behavior
Success	Success	0000	The SCP has successfully received the SOP Instance. The received SOP Instances, grouped by patient, study or series, will be written on a medium (CD or DVD), or will be used to create jpeg images which will be written on a medium.
Refused	Out of resources	A700	Indicates that there was a lack of resource that prevents the dataset to be received, eg: dataset could not be saved to disk, out of memory, ... The Association is aborted using A-ABORT
Error	SOP Class not supported	A800	Received C-STORE-RQ for non-storage SOP class The Association is aborted using A-ABORT
Error	Data set does not match	A900	SOP class or instance UID in C-STORE-RQ does not match UIDs in the received dataset. The Association is aborted using A-ABORT
Error	Cannot Understand	C000	Received dataset without SOP class or instance UID or internal application error The Association is aborted using A-ABORT

### 3.2.2.6.3 Activity Query and Retrieve

#### 3.2.2.6.3.1 Description and Sequencing of Activities

MARS AE will accept associations from systems that want to query MARS database and retrieve datasets using the C-FIND or C-MOVE commands.

**Figure 3.2.2.6.3.1-1: Sequencing of Activity – Query and Retrieve**

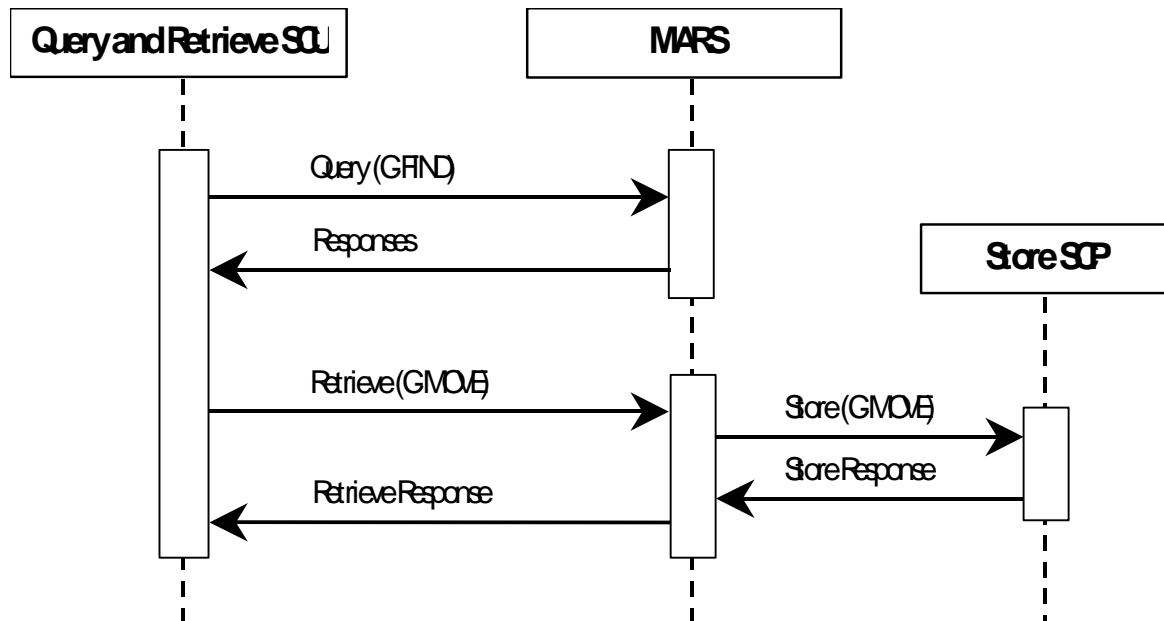

The figure above is a typical sequence of messages between a Query and Retrieve SCU and MARS:

1. The Query and Retrieve SCU opens an association with MARS.
2. The SCU sends a C-FIND request.
3. MARS searches for matching items in its internal database, according to request filters.
4. MARS sends the list of items to the SCU.
5. The SCU may choose to retrieve some items
  - The SCU sends a C-MOVE request to MARS, specifying the identifiers of items to move and the AETitle of the destination. (The destination may be the same as the Query Retrieve SCU)
  - MARS then acts as a Store SCU, and opens an association with the Store SCP specified.
  - MARS sends the specified items to the Store SCP using C-STORE commands
  - MARS waits for the response from the Store SCP and notifies the Query SCU.
  - MARS closes the association with the Store SCP.
  - MARS returns the response to the SCU.
6. The SCU closes the association.



### 3.2.2.6.3.2 Accepted Presentation Contexts

**Table 3.2.2.6.3.2-1: Acceptable Presentation Contexts for MARS AE and Query Retrieve Activity**

Presentation Context Table						
Abstract Syntax			Transfer Syntax		Role	Extended Negotiation
Name		UID	Name List	UID List		
Study Find	Root	1.2.840.10008.5.1.4.1.2 .2.1	Implicit VR Little Endian	1.2.840.10008.1.2	SCP	None
Study Find	Root	1.2.840.10008.5.1.4.1.2 .2.1	Explicit VR Little Endian	1.2.840.10008.1.2 .1	SCP	None
Study Move	Root	1.2.840.10008.5.1.4.1.2 .2.2	Implicit VR Little Endian	1.2.840.10008.1.2	SCP	None
Study Move	Root	1.2.840.10008.5.1.4.1.2 .2.2	Explicit VR Little Endian	1.2.840.10008.1.2 .1	SCP	None

### 3.2.2.6.4 SOP Specific Conformance to Query and Retrieve SOP Class

MARS provides standard conformance to the DICOM Query and Retrieve Service Class.

No control is made concerning the Abstract/Transfer syntax consistency.

MARS will prefer, for query and retrieve operations, in decreasing order:

- Explicit VR Little Endian transfer syntax
- Implicit VR Little Endian transfer syntax

#### **C-FIND SCP Conformance**

Queries against the standard Study Root Query/Retrieve Information Model are supported to return attribute values of Objects known to MARS, as recorded in its database.

Optional keys supported for the Study Root Q/R Model are listed in the table below. The support differs based on the query level specified in the required Level Tag (0008,0052).



**Table 3.2.2.6.4-1: Query Matching Key Type**

Key Type	Matching
SV	Single value matching
UID	List of UID matching
UM	Universal matching
WC	Wild card matching
RM	Range matching
SQ	Sequence matching
	No matching. Returns value when available



**Table 3.2.2.6.4-2: Query and Retrieve Supported Attributes for C-FIND**

Module	Attribute Name	Tag	Match	
SOP Common	Specific Character Set	(0008,0005)		
STUDY	Study Instance UID	(0020,000D)	UID	
	Study ID	(0020,0010)	SV,WC	
	Study Date	(0008,0020)	SV,RM	
	Study Time	(0008,0030)		
	Accession Number	(0008,0050)	SV,WC	
	Study Description	(0008,1030)	SV,WC	
	Referring Physician's Name	(0008,0090)	SV,WC	
	Modalities in Study	(0008,0061)	SV	
	Number of Study Related Series	(0020,1206)		
	Number of Study Related Instances	(0020,1208)		
	Patient's Name	(0010,0010)	SV,WC *	
	Patient ID	(0010,0020)	SV,WC	
	Issuer of Patient ID	(0010,0021)		
	Patient's Birth Date	(0010,0030)	SV,RM	
	Patient's Sex	(0010,0040)	SV,WC	
	Number of Patient Related Studies	(0020,1200)		
	Number of Patient Related Series	(0020,1202)		
	Number of Patient Related Instances	(0020,1204)		
	SERIES	Series Instance UID	(0020,000E)	UID
		Series Date	(0008,0021)	SV,RM
Series Time		(0008,0031)		
Modality		(0008,0060)	SV,WC	
Series Description		(0008,103E)	WC	
Series Number		(0020,0011)		
Institution Name		(0008,0080)	SV,WC	
Performing Physician's Name		(0008,1050)	SV,WC	
Number of Series Related Instances		(0020,1209)		
INSTANCE		SOP Instance UID	(0008,0018)	UID
	SOP Class UID	(0008,0016)	UID	
	Instance Number	(0020,0013)		
	Number of Frames	(0028,0008)		

\* For patient name matching, a case and diacritics insensitive match is performed (e.g. "èè" matches "eÉ"). The matching is tested on the single byte part, the ideogram part and the phonetic part of the patient name.



**Table 3.2.2.6.4-3: Query and Retrieve C-FIND Response Status Reasons**

Service Status	Further Meaning	Error Code	Reason
Success	Matching complete is	0000	
Failure	Unable to process	C000	This status is returned due to internal errors within MARS. The response status and meaning are logged into the database and log file.
Cancel	Matching terminated due to cancel request	FE00	This status is returned if a Cancel request is received from the SCU while processing a C-FIND request.
Pending	Matching continuing is	FF00	The status is returned with each matching response.

**C-MOVE SCP Conformance**

The MARS AE supports C-MOVE sub-operations for each of the Storage Service Class SOP Classes list in table 3.2.1-1.

When performing C-STORE operations on behalf of a C-MOVE request from a remote DICOM application entity, periodic C-MOVE PENDING response messages are sent to the C-MOVE SCU for each object. The MARS AE notifies the remote C-MOVE SCU about the number of successful, failed, refused or warning messages received from the remote C-STORE SCP.

### 3.3 Network Interface

#### 3.3.1 Physical Network Interface

MARS provides DICOM V3.0 TCP/IP Network Communication Support as defined in Part 8 of the DICOM Standard.

MARS inherits its TCP/IP stack from the Windows system where it runs. Default Windows TCP/IP stack is supported.

MARS supported physical medium depends on the hardware solution chosen as a support for MARS software solution.

MARS can support multiple network interface (Ethernet ISO.802-3).

**Table 3.3.1-1: Available standards**

Ethernet 10 baseTX
Ethernet 100 baseTX
Ethernet 1000 baseTX

#### 3.3.2 Additional Protocols

None.

### 3.4 Configuration

MARS can be configured from its Web interface .

#### 3.4.1 AE Titles / Presentation Address Mapping

##### 3.4.1.1 Local AETitles

The final behaviour of MARS depends on the called AE Title at the images store.

By default, the MARS AE presents 4 AETitles ; 3 of them will be used for the MARS CD/DVD creation: "CD\_PATIENT", "DVD\_ARCHIVE", "CD\_PATIENT\_SR". Depending on the called AETitle, MARS can create CD or DVD, create one medium per patient or multipatient media... The complete list of parameters is reported in MARS administrator manual. Number of AETitles that can be added to MARS is unlimited.

The last MARS default AE Title, "MARS", is the main AE Title used for the receiving or retrieving images.

**Table 3.4.1.1-1: AE Title Configuration Table**

Application Entity	Default AE Title(s)	Default TCP / IP Port
MARS	CD_PATIENT,DVD_ARCHIVE, CD_PATIENT_SR, MARS	8009

### 3.4.1.2 Remote AETitle / Presentation Address Mapping

MARS AE uses remote AE Titles. There is no default remote AE configured. Any remote AE shall be configured using the MARS interface.

AE Titles, host names and port numbers for remote applications are configured using the **Configuration / DICOM Applications** tab of the Web interface. This mapping is used by MARS for Verification Service Class as SCP.

### 3.4.2 Parameters

MARS configurable parameters can be defined in the **Configuration** panel. They are the following:

- TCP/IP port: default is 8009
- AE Title: default is either MARS or the PC hostname. However, MARS does not check this.
- Maximum number of simultaneous associations: default is 5.
- Debug and Verbose modes: to get or not detailed information about connections.

## 4 Media Interchange

### 4.1 Implementation Model

The MARS product may be configured with CD only, DVD only or a CD/DVD combination drive.

MARS media production is implemented in 1 Application entity.

#### 4.1.1 Application Data flow

The DICOM interface for the CD-Medical product supports Media Storage implementation of the 120mm CD-R medium, 120 mm DVD-R medium and 120 mm DVD+R medium.

**Figure 4.1.1-1: Application Data Flow**

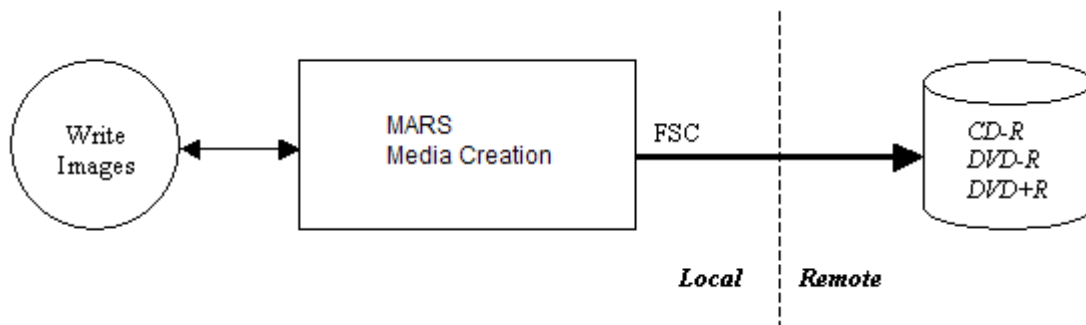

#### 4.1.2 Functional Definitions of Application Entities

##### 4.1.2.1 Functional Definition of Media Creation Application Entity

The Entity initializes a piece of CD/DVD medium, writes on it images received using Storage or Retrieve Service, and a Media Storage Directory IOD (DICOMDIR) corresponding to the images on medium and to the selected application profile.

Note that other, non DICOM, files may also be written onto the media.

##### 4.1.3 Sequencing of Real-Word Activities

The operator can select DICOM images from a remote equipment and store them to MARS or the user can query a Q&R SCP from the web interface and moves image to MARS. After having received images from a remote equipment or after having moved images using web interface, MARS produces DICOM CD or DVD without any user interaction.

##### 4.1.4 File Meta Information for Implementation Class and Version

The Implementation Class UID and the Implementation Version Name are different depending on the file type. The DICOMDIR created by the robot and written on the media is matching the table 5.1-1. The other DICOM files are not modified after reception and they keep their Implementation Class UID and Implementation Version Name.

**Table 4.1.4-1: DICOM Implementation Class and Version for MARS DICOMDIR creation**

File Meta information Version	00, 01
Implementation Class UID	1.2.250.1.59.453.260
Implementation version name	ACC_ETIAM_260

#### 4.2 Application Entity Specifications

##### 4.2.1 CD/DVD Creation Application Entity Specification

CD/DVD Creation AE provides Standard Conformance to the DICOM Interchange Option of the Media Storage Service Class.

**Table 4.2.1-1: Application Entity related Application Profiles, Real-World activities, and Roles**

Supported Application Profile	Real-World Activity	Roles	SC Option
<b>Compact Disk – Recordable</b>			
STD-GEN-CD	Write Media	FSC	Interchange
STD-CTMR-CD	Write Media	FSC	Interchange
STD-XABC-CD	Write Media	FSC	Interchange
STD-DEN-CD	Write Media	FSC	Interchange
STD-US-CD	Write Media	FSC	Interchange
<b>DVD</b>			
STD-GEN-DVD	Write Media	FSC	Interchange
STD-DVD-MPEG2-MPML	Write Media	FSC	Interchange

Note that MARS never acts as a FSU (i.e. CD/DVD can't be produced in multi-session mode).

#### **4.2.1.1 File Meta Information for the Media Creation Application Entity**

The source Application Entity Title, which is an optional attribute, is not written to the DICOM files created by MARS.

#### **4.2.1.2 Real-World Activities**

##### **4.2.1.2.1 Write Images**

When images have been received by MARS or moved to it using Query And Retrieve service, then the MARS acts as an FSC using the interchange option to export SOP Instances from the local database to a CD-R or DVD medium.

##### **4.2.1.2.1.1 Media Storage Application Profile**

The MARS supports the RWA Write Images for the 11 Application Profiles listed in table 5.2-1.

##### **4.2.1.2.1.1.1 Options**

For a complete presentation of MARS CD/DVD Creation, refer to MARS administrator manual.

### **4.3 Augmented and Private Application Profiles**

#### **4.3.1 Augmented Application Profiles**

MARS provides Augmented Conformance to the STD-GEN-CD and STD-GEN-DVD with the FULL-GEN-CD-DVD profile, a private and very generic profile that support all DICOM images without any restriction.



### 4.3.1.1 FULL-GEN-CD-DVD

**Table 4.3.1.1-1: Augmented Application Profile**

Supported Application Profile	Real-World Activity	Roles	SC Option
FULL-GEN-CD-DVD (Private)	Write Media	FSC	Interchange

#### 4.3.1.1.1 SOP Classes augmentation

FULL-GEN-CD-DVD Augmented Application Profiles supports all DICOM images without any restriction.

#### 4.3.1.1.2 Directory Augmentation

None.

#### 4.3.1.1.3 Other Augmentation

None.

## 4.4 Media Configuration

Media configuration depends on the called AETitle used to store images to burn. The following table shows parameters that can be set for each AE Title.

**Table 4.4-1: Media Configuration**

Parameter	Configurable	Default Value
Application Profile	Yes	FULL-GEN-CD-DVD
Add IconImageSequence to DICOMDIR Image Level	Yes	No
Add IconImageSequence to DICOMDIR Series Level	Yes	No
Icon Image size	Yes	No

**Note:** the Icon Image must be square. Icon Image size represent the image side in pixel, and it can be set to 64 or 128



## 5 Support of Extended Character Sets

MARS supports all character sets defined by the DICOM Standard.

Whether or not characters are displayed correctly depends on the presence of font support in the underlying operating system. It may be necessary for the user to add additional Unicode fonts to their system configuration in order to correctly display characters that would not typically be used in the default locale.

**Table 5-1: Supported specific character set defined terms**

Character Set Description	Defined Term	Supported
<b>Single-byte character sets without code extensions</b>		
Default Repertoire	None	YES
Latin alphabet No. 1	ISO_IR 100	YES
Latin alphabet No. 2	ISO_IR 101	YES
Latin alphabet No. 3	ISO_IR 109	YES
Latin alphabet No. 4	ISO_IR 110	YES
Cyrillic	ISO_IR 144	YES
Arabic	ISO_IR 127	YES
Greek	ISO_IR 126	YES
Hebrew	ISO_IR 138	YES
Latin alphabet No. 5	ISO_IR 148	YES
Japanese	ISO_IR 13	YES
Thai	ISO_IR 166	YES
<b>Single-byte character sets with code extensions</b>		
Default Repertoire	ISO 2022 IR 6	YES
Latin alphabet No. 1	ISO 2022 IR 100	YES
Latin alphabet No. 2	ISO 2022 IR 101	YES
Latin alphabet No. 3	ISO 2022 IR 109	YES
Latin alphabet No. 4	ISO 2022 IR 110	YES
Cyrillic	ISO 2022 IR 144	YES
Arabic	ISO 2022 IR 127	YES
Greek	ISO 2022 IR 126	YES
Hebrew	ISO 2022 IR 138	YES
Latin alphabet No. 5	ISO 2022 IR 148	YES



Revision: 12  
Date: June 2016

Character Set Description	Defined Term	Supported
Japanese	ISO 2022 IR 13	YES
Thai	ISO 2022 IR 166	YES
<b>Multi-byte character sets with code extensions</b>		
Japanese	ISO 2022 IR 87	YES
Japanese	ISO 2022 IR 159	YES
Korean	ISO 2022 IR 149	YES
<b>Multi-byte character sets without code extensions</b>		
Unicode in UTF-8	ISO_IR 192	YES
Chinese GB18030	GB18030	YES



## 6 Security

MARS does not support any specific security measures.

It is assumed that MARS is used within a secured environment, including:

- Router protections to ensure that only approved external hosts have network access to MARS
- Router protections to ensure that MARS only has network access to approved external hosts and services
- Any communication with external hosts and services outside the locally secured environment use appropriate secure network channels

## 7 Annexes

### 7.1 IOD Contents

#### 7.1.1 *Created SOP Instances*

MARS generates the Media Storage Directory IOD (DICOMDIR) corresponding to images on media and selected application profile. The following tables specify the directory records keys and optional attributes in the Media Storage Directory IOD.



**Table 7.1.1-1: DICOMDIR PATIENT Record Keys**

Tag	Name	Type	Match
(0008,0005)	Specific Character Set	1C	As in first Image Instance
(0010,0010)	Patient's Name	2	As in first Image Instance
(0010,0020)	Patient ID	1	As in first Image Instance
(0010,0030)	Patient Birth Date	2	As in first Image Instance
(0010,0040)	Patient's Sex	2	As in first Image Instance

T

**Table 7.1.1-2: DICOMDIR STUDY Record Keys**

Tag	Name	Type	Match
(0008,0005)	Specific Character Set	1C	As in first Image Instance
(0008,0020)	Study Date	1	As in first Image Instance
(0008,0030)	Study Time	1	As in first Image Instance
(0008,1030)	Study Description	2	As in first Image Instance ; when absent: insert zero length value.
(0020,000D)	Study Instance UID	1C	As in first Image Instance
(0020,0010)	Study ID	1	As in first Image Instance
(0008,0050)	Accession Number	2	As in first Image Instance



**Table 7.1.1-3: DICOMDIR SERIES Record Keys**

Tag	Name	Type	Match
(0008,0005)	Specific Character Set	1C	As in first Image Instance
(0008,0060)	Modality	1	As in first Image Instance
(0020,000E)	Series Instance UID	1	As in first Image Instance
(0020,0011)	Series Number	1	As in first Image Instance
(0008,0080)	Institution Name	2	As in first Image Instance ; when absent: insert zero length value.
(0008,0081)	Institution Address	2	As in first Image Instance ; when absent: insert zero length value.
(0008,1050)	Performing Physician	2	As in first Image Instance ; when absent: insert zero length value.
(0008,103E)	Series Description	2	As in first Image Instance ; when absent: insert zero length value.
(0088,0200)	IconImageSequence	3	
> (0028, 0002)	Samples per Pixel	1	As in first Image Instance
> (0028,0004)	Photometric Interpretation	1	MONOCHROME 2 (see note)
> (0028,0006)	PlanarConfiguration	1C	0
> (0028,0010)	Rows	1	64 or 128 (configurable)
> (0028,0011)	Columns	1	64 or 128 (configurable)
> (0028,0100)	BitsAllocated	1	8
> (0028,0101)	BitsStored	1	8
> (0028,0102)	HighBit	1	7
> (0028,0103)	PixelRepresentation	1	0
<b>Note</b> > (7FE0,0010)	PixelData	1	Computed using first image instance pixel data and rows / columns configuration

**Note:** IconImageSequence is optional and only applicable on grayscale images.



**Table 7.1.1-4: DICOMDIR IMAGE Record Keys**

Tag	Name	Type	Match
(0008,0005)	Specific Character Set	1C	As in the related Image Instance
(0020,0013)	Instance Number	1	As in the related Image Instance
(0008,0008)	Image Type	2	As in the related Image Instance ; when absent: insert zero length value.
(0028,0008)	NumberOfFrames	1	As in the related Image Instance
(0028,0010)	Rows	1	As in the related Image Instance
(0028,0011)	Columns	1	As in the related Image Instance
(0088,0200)	IconImageSequence	3	
> (0028,0002)	Samples per Pixel	1	As in the related Image Instance
> (0028,0004)	Photometric Interpretation	1	MONOCHROME 2 (see note)
> (0028,0006)	PlanarConfiguration	1C	0
> (0028,0010)	Rows	1	64 or 128 (configurable)
> (0028,0011)	Columns	1	64 or 128 (configurable)
> (0028,0100)	BitsAllocated	1	8
> (0028,0101)	BitsStored	1	8
> (0028,0102)	HighBit	1	7
> (0028,0103)	PixelRepresentation	1	0
<b>Note</b> (7FE0,0010)	PixelData	1	Computed using the related image instance pixel data and rows / columns configuration

**Note:** IconImageSequence is optional and only applicable on grayscale images.



**Table 7.1.1-5: DICOMDIR SR DOCUMENT Record Keys**

Tag	Name	Type	Match
(0008,0005)	Specific Character Set	1C	As in the related Instance
(0020,0013)	Instance Number	1	As in the related Instance
(0008,0023)	Content Date	1	As in the related Instance
(0008,0033)	Content Time	1	As in the related Instance
(0040,A491)	Completion Flag	1	As in the related Instance
(0040,A493)	Verification Flag	1	As in the related Instance
(0040,A030)	Verification Date Time	1C	As in the related Instance
(0040,A043)	Concept Name Code Sequence	1	As in the related Instance
(0040,A730)	Content Sequence	1C	As in the related Instance

**Table 7.1.1-6: DICOMDIR KEY OBJECT DOC Record Keys**

Tag	Name	Type	Match
(0008,0005)	Specific Character Set	1C	As in the related Instance
(0020,0013)	Instance Number	1	As in the related Instance
(0008,0023)	Content Date	1	As in the related Instance
(0008,0033)	Content Time	1	As in the related Instance
(0040,A043)	Concept Name Code Sequence	1	As in the related Instance
(0040,A730)	Content Sequence	1C	As in the related Instance





**Table 7.1.1-7: DICOMDIR PRESENTATION Record Keys**

Tag	Name	Type	Match
(0008,0005)	Specific Character Set	1C	As in the related Instance
(0020,0013)	Instance Number	1	As in the related Instance
(0070,0080)	Content Label	1	As in the related Instance
(0070,0081)	Content Description	2	As in the related Instance
(0070,0082)	Presentation Creation Date	1	As in the related Instance
(0070,0083)	Presentation Creation Time	1	As in the related Instance
(0070,0084)	Content Creator's Name	1	As in the related Instance
(0008,1115)	Referenced Series Sequence	1	As in the related Instance
(0020,000E)	> Series Instance UID	1C	As in the related Instance
(0008,1140)	> Referenced Image Sequence	1C	As in the related Instance
(0008,1150)	>> Referenced SOP Class UID	1C	As in the related Instance
<b>T</b> <b>a</b> <b>b</b> (0008,1155)	>> Referenced SOP Instance UID	1C	As in the related Instance

**Table 7.1.1-8: DICOMDIR WAVEFORM Record Keys**

Tag	Name	Type	Match
(0008,0005)	Specific Character Set	1C	As in the related Instance
(0020,0013)	Instance Number	1	As in the related Instance
(0008,0023)	Content Date	1	As in the related Instance
(0008,0033)	Content Time	1	As in the related Instance



**Table 7.1.1-9: DICOMDIR RAW DATA Record Keys**

Tag	Name	Type	Match
(0008,0005)	Specific Character Set	1C	As in the related Instance
(0020,0013)	Instance Number	1	As in the related Instance
(0008,0023)	Content Date	1	As in the related Instance
(0008,0033)	Content Time	1	As in the related Instance

**Table 7.1.1-10: DICOMDIR ENCAP DOC Record Keys**

Tag	Name	Type	Match
(0008,0005)	Specific Character Set	1C	As in the related Instance
(0020,0013)	Instance Number	1	As in the related Instance
(0008,0023)	Content Date	2	As in the related Instance
(0008,0033)	Content Time	2	As in the related Instance
(0042,0010)	Document Title	2	As in the related Instance
(0040,A043)	Concept Name Code Sequence	2	Always empty
(0042,0012)	MIME Type of Encapsulated Document	1	As in the related Instance

### **7.1.2 Usage of Attributes from Received IOD's**

The patient's name (0010,0010) and patient's ID (0010, 0020) are used to group the SOP Instances received by MARS AE.

When configured, IconImageSequence addition to DICOMDIR need the following attributes to be present in the received SOP Instances:

**Table 7.1.2-1: Attributes used by IconImageSequence addition**

Tag	Name
(0028, 0002)	Samples per Pixel
(0028,0004)	Photometric Interpretation
(0028,0006)	PlanarConfiguration
(0028,0010)	Rows
(0028,0011)	Columns
(0028,0100)	BitsAllocated
(0028,0101)	BitsStored
(0028,0102)	HighBit
(0028,0103)	PixelRepresentation
(7FE0,0010)	PixelData

### **7.1.3 Attribute mapping**

Not applicable.

### **7.1.4 Coerced/Modified fields**

No coercion is performed.

## **7.2 Data Dictionary of Private Attributes**

Not applicable.

## **7.3 Coded Terminology and Templates**

Not applicable.

## **7.4 Grayscale Image Consistency**

Not applicable.

## **7.5 Standard Extended/Specialized/Private SOP Classes**

Not applicable.

## **7.6 Private Transfer Syntaxes**

None.